



FREGADEROS Y GRIFOS

FREGADEROS

Fregaderos de alta calidad, fabricados en acero inoxidable AISI 304, con acabado Liso Pulido, que mejora la resistencia al desgaste, la corrosión y la oxidación. Fácil de limpiar.
Cubetas de 200 mm de profundidad, para una mayor capacidad.
Incluye válvula con rebosadero, desagüe tradicional y sifón.
Distintos modelos y 2 opciones de colocación: bajo encimera o sobre encimera.



GRIFOS

Grifos que combinan el diseño y la calidad.
Variedad de acabados, para hacer del grifo un elemento más de decoración.
Modelos con funciones especiales: abatible, caño extraíble o caño flexible.
También disponemos de prácticos **dispensadores de jabón**, para encastrar junto al grifo.



FREGADEROS BAJO ENCIMERA

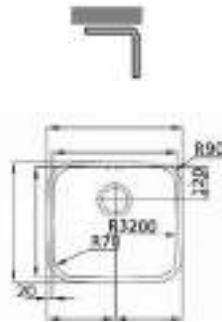

RODI
sinks and ideas

Referencia	Medidas	Modelo
FG43.4040	400 x 400	BAHIA
FG43.4045	450 x 400	LAGUNA
FG43.4050	500 x 400	BELEM

Acero inoxidable AISI 304 18/10.
Cubetas de 200 mm de profundidad.



BAHIA



LAGUNA



BELEM



Diseño elegante, con ángulos más rectos.
Acero inoxidable AISI 304, espesor 0,8 mm.
Cubetas de 200 mm de profundidad.

Referencia	Medidas	Modelo
FG8BER4040	400 x 400	BERLIN
FG8BER4045	450 x 400	MUNICH
FG8BER4050	500 x 400	HANNOVER



BERLIN



MUNICH



HANNOVER

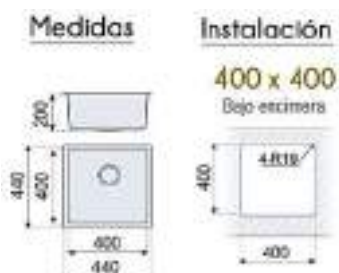

FREGADEROS SOBRE ENCIMERA



Diseño elegante, con ángulos más rectos. Acero inoxidable AISI 304, espesor 0,8 mm. Cubetas de 200 mm de profundidad.

Referencia	Medidas	Modelo
FG8BER4040	440 x 440	BERLIN
FG8BER4045	490 x 440	MUNICH
FG8BER4050	540 x 440	HANNOVER



BERLIN



MUNICH



HANNOVER

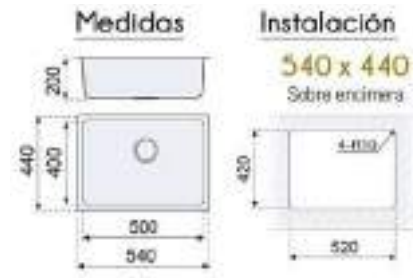
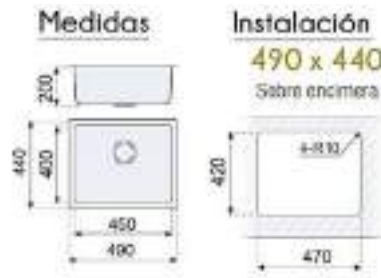

FREGADEROS SOBRE ENCIMERA ELEVADO

Fregadero con agujero para instalar el grifo. Acero inoxidable AISI 304, espesor 0,6 mm. Cubeta de 180mm de profundidad.



PIO REDONDO

Referencia	Medidas	Modelo
FG43.RED	Ø 490	PIO REDONDO

FREGADEROS SOBRE ENCIMERA ELEVADO

Acero inoxidable AISI 304, espesor 0,6 mm.
Cubeta de 160mm de profundidad.



VIENA35

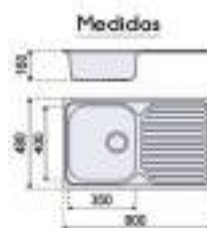

VIENA40

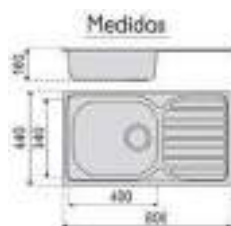

Referencia	Medidas	Modelo
FG8742	800 x 480	VIENA35
FG8743	800 x 440	VIENA40

Líneas rectas y actuales.
Acero inoxidable AISI 304, espesor 1,2 mm.
Cubeta de 215mm de profundidad.



PRODUCTO BAJO PEDIDO



NEW YORK

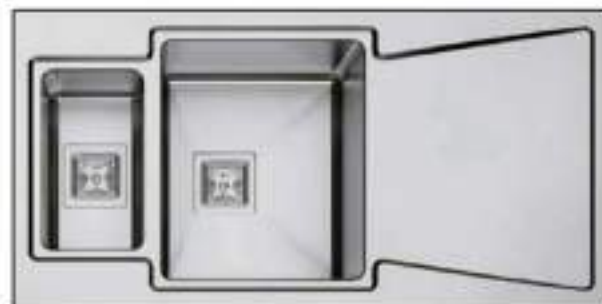

BOSTON

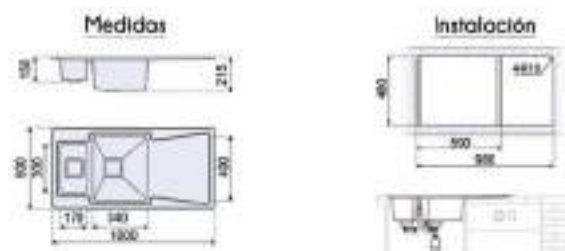
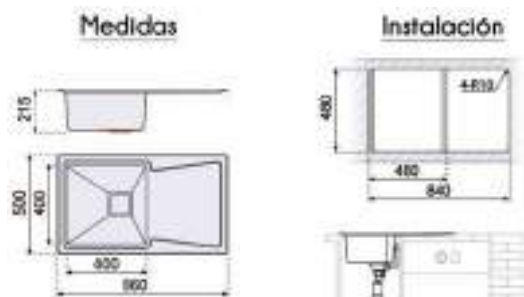

Referencia	Medidas	Modelo
FG8730	860 x 500	NEW YORK
FG8731	1000 x 500	BOSTON

GRIFOS

NERVIÓN



Monomando cromado.
Cartucho cerámico de 35 mm.
Caño giratorio.
Aireador de latón con núcleo interno Neoperl.
Latiguillos F3/8xM10x1 x 36 cm.

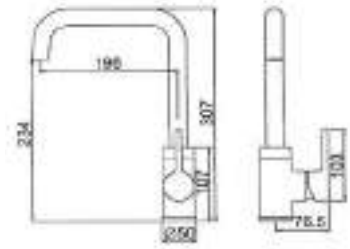

Referencia	Acabado
G84NERVION	Cromo brllo

DANUBIO



Monomando fabricado en
acero inox SUS304.
Cartucho cerámico de 35 mm.
Caño giratorio.
Aireador de latón con núcleo
interno Neoperl.
Latiguillos F3/8xM10x1 x 36 cm

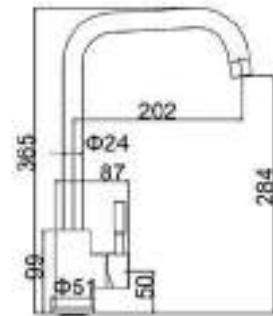

Referencia	Acabado
G84DANUBIO	Inox

VOLGA



Monomando en color negro.
Cartucho cerámico de 35 mm.
Caño giratorio.
Aireador de latón con núcleo
interno Neoperl.
Latiguillos F3/8xM10x1 x 36 cm

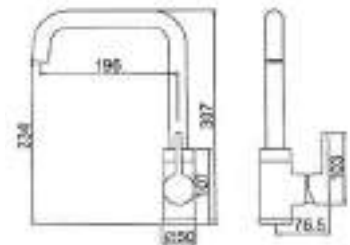

Referencia	Acabado
G84VOLGA	Negro

GRIFOS

VENECIA

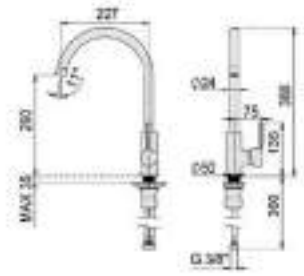

Monomando con caño giratorio.
 Cartucho cerámico de 35 mm,
 apertura en frío.
 Aireador anti-calcáreo.
 Disponible en 3 acabados:
 Cromo brillo, Blanco y Negro.
 Latiguillos F3/8xM10x1 x 36 cm.

Referencia	Acabado
G8CVENECIA	Cromo brillo
G8BVENECIA	Blanco
G8NVENECIA	Negro

RIVER



Monomando fabricado en
 acero inox SUS304.
 Cartucho cerámico de 25 mm.
 Caño giratorio.
 Aireador con núcleo interno
 Neoperl.
 Latiguillos F3/8xM10x1 x 36 cm

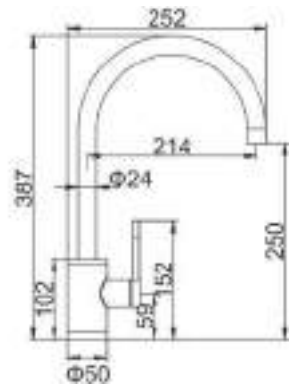

Referencia	Acabado
G84RIVER	Inox/Negro

TIBER (caño flexible)

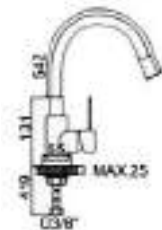

Monomando fabricado en
 acero inox SUS304, con **caño
 flexible**.
 Cartucho cerámico de 35 mm.
 Aireador de latón, con núcleo
 interno Neoperl.
 Latiguillos F3/8xM10x1

Referencia	Acabado
G84TIBER	Negro/Inox

GRIFOS

TORNADO (ducha extraíble)



Monomando con caño alto fabricado en latón.
 Cartucho cerámico de 35mm con sistema Sweet Move para un movimiento suave.
 Caño giratorio y extensible 75 cm.
Ducha extraíble con 2 funciones, y con aireador anti-calcáreo.
 Cartucho con ahorro energético.
 Conexiones flexibles normalizadas.
 Latiguillos F3/8xM10x1 x 36 cm.



Referencia	Acabado
G8TORNADO	Cromo brillo

LOIRA (abatible)



Monomando con **caño abatible**.
 Cartucho cerámico de 40 mm.
 Aireador de latón con núcleo interno Neoperl.
 Latiguillos F3/8xM10x1 x 40 cm.



Referencia	Acabado
G84LOIRA	Cromo brillo

DISPENSADOR DE JABÓN (para encastrar en la encimera)

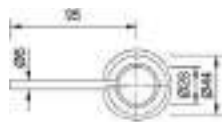

Rodi
sinks and ideas

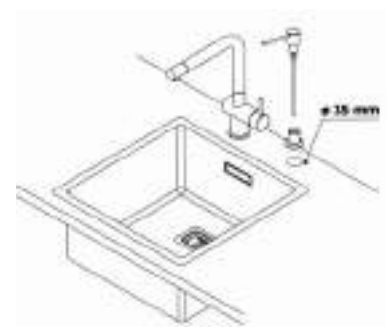
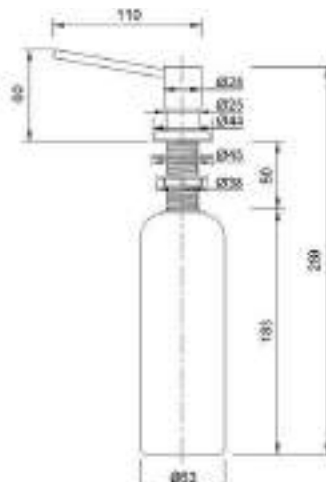

Referencia	Acabado
FG43.300	Cromo brillo